



International Journal of Marketing Management

ISSN 2454 - 5007



www.ijmm.net

Email ID: editor@ijmm.net , ijmm.editor9@gmail.com

Performance of ANFIS controller for SRM-Based Hybrid Electrical Vehicle Applications

(SOMBATHINITEJDEEPTHEOPHILUS1Dr.J.SRINUNAICK2Mr.K.SIVAKUMAR3)

Abstract_ As proposed in this paper, a performance-based hybrid ANFIS controller for SRM-based vehicles can be implemented, allowing the generator/air conditioning matrix to be more flexible in terms of how much power it can deliver to the battery bank and engine while also performing battery the board (BM) work for condition of charge (SOC) balance control and transport voltage guidelines. Battery packs are being integrated into AHB converters in order to design staggered transport voltage and current limits, which can speed up the excitation and demagnetization processes during recompense, widen the speed range and reduce voltage on the switches while increasing force capacity and framework efficiency. Different driving modes, regeneration slowing modes, and charging modes are all ready in the suggested converter, as demonstrated by the wide range of activity prerequisites. A major benefit of the proposed BM system is the flexibility with which each battery pack can be connected or disconnected from the force. failure capacity and successfully avoid cheating and overcharging concerns during engine operation. Fell multiport SRM drive's practicality and appropriateness have been tested on a three-stage 12/8 SRM.

I. Introduction

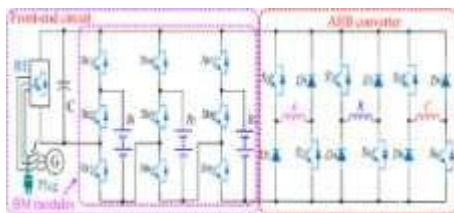

In light of the growing concerns about the petroleum derivative crisis and natural disaster, electric cars (EVs) and half and half electric vehicles (HEVs) have gained increasing attention because of their reduced fuel consumption and improved energy efficiency.

[1]-[4]. PMSMs have consistently dominated the roost in EV and HEV powertrain frameworks because of their supreme force and force densities [5]-[7]. With the rapid depletion and rising cost of rare earth magnets, unusual earth-less and rare earth-free engines are becoming more popular. SRMs (exchanged hesitance engines) are becoming increasingly used as a non-earth engine.a promising option because of their basic

1(M.TECH,DEPTOFELECTRICALELANDELECTRONICS
ENGINEERING,CHADALAWADARAMANAMMAENGINEERINGCOLLEGE,TIRUPATHI-517506.
EMAILID:theo.teju@gmail.com

2(ASSOCIATEPROFESSOR,DEPTOFELECTRICALELANDELECTRONICSENGINEERING, CHADALAWADA
RAMANAMMA ENGINEERINGCOLLEGE,TIRUPATHI-517506.
EMAILID:speaksrinu@gmail.com

3(HEADOFTHEDPARTMENT,DEPTOFELECTRICALELANDELECTRONICSENGINEERING, CHADALAWADA
RAMANAMMA ENGINEERINGCOLLEGE,TIRUPATHI-517506.
EMAILID:k.siva96@gmail.com

structure, minimal effort, extraordinary heat resistance, high dependability, and solid appropriateness for brutal conditions [10]-[13]. To improve the engine execution over more extensive speed run, numerous voltage-boosting converters are created in the SRM framework. Consequently, to control the vitality transformation for the EVs and HEVs, a vital it y proficient and high-unwavering quality BM framework is typically necessary. The bank is divided into numerous smaller units with equal battery cells, each of which is coupled to the rest of the bank in a certain arrangement, to achieve variable voltage and a bigger current limit. One switch regulates each cell's SOC and improves its ability to respond to non-critical failure. In order to produce a BM module that can be

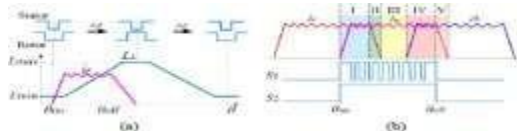

utilized for even warm appropriation, we used an improved simultaneous bidirectional converter and a battery cell. A falling multiport converter is presented for adaptive energy transformation in the SRM-based HEV architecture. Regenerative braking and recharging modes can all be used in the manner advised by the manufacturer.

Fig.1. Proposed cascaded multiport converter for a three-phase SRM.

II. PROPOSED

CASCADED MULTIPORT SRM DRIVE FOR HEV APPLICATIONS

A. Proposed Converter Topology

High-efficiency energy transfer between the generator/air-conditioning lattice, battery bank, and SRM for HEV applications is shown in Figure 1 by an impressively integrated multiport converter with BM work. In order to connect the generator and rectifier, a hand-

off J is used; an attachment is used to connect the air conditioner matrix, and three BM modules are introduced for work representation. With the AHB converter, the generator/dc rectifier plug, the air conditioner/dc rectifier, and the BM modules, the layout is clearly connected. You can now make use of this converter going forward and a front-end circuit and an AHB converter have been merged into a single circuit. Besides charging the battery bank and powering SRM, a generator can be utilized as a starter engine [15]. The SRM and air conditioner matrix can also be used to charge the battery bank. The battery bank or the generator can power the SRM. Each additional BM module has a battery pack, three force switches with a hostile diode, and a hostile diode on each of the three force switches. The proposed topography allows for a wide range of driving modes, regenerative slowing down modes, and charging to fulfill the needs of different activities. modes. Modes of Operation

Operation Principle of Driving Modes for SRM

When the SRM is in driving mode, the stage current and stage inductance are shown in Figure 2a. When the SRM is in the driving mode, i_k and L_k are the k th stage current and stage inductance, respectively. Ideally, stage winding should take place in the area with rising inductance. Signals S_1 and S_2 are represented in Fig. 2b as exchanging signals in Stage A. Each section of the stage A conduction scope is depicted in the diagram. In Region I, Stages C and An are both directing simultaneously. Stage C's presence in the second region lessens over time. Stage C is no longer in charge in Region III; only stage An is now in charge. In addition, the phase is A is disabled in Region V.

Fig. 2. Driving operation condition. (a) Phase current and phase inductance. (b) Phase currents and drive signals.

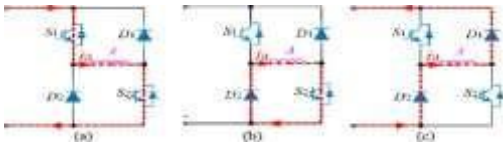
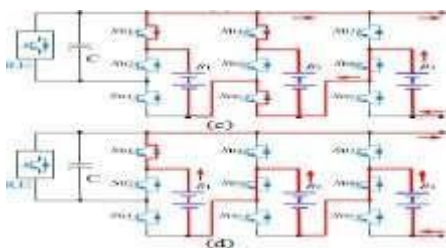
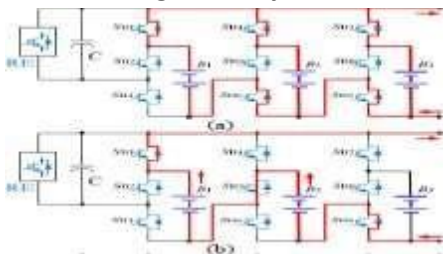

Fig.3. Operation states of AHB converter. (a) Excitation state. (b) Freewheeling state. (c) Demagnetization state.

1) In the first four regions of phase A, there are two switching states, excitation and zero-voltage freewheeling. A positive dc voltage is given to the winding of phase A when both the upper- and lower-switch of phase A (i.e., S1 and S2) are turned on (a). Phase winding voltage is zero when upper switch S1 is off and lower switch S2 is on, as shown in Fig. 3 for the zero-voltage freewheeling state (b). Figure 3(c) shows the demagnetization state of the phase A winding in Region V, where both switches are disabled and diodes D1 and D2 are turned on to feed power back to the power supply.

2) Driving Modes by the Generator



3) When the relay J is turned on and all the switches in the front-end circuit are turned off, the generator is the only

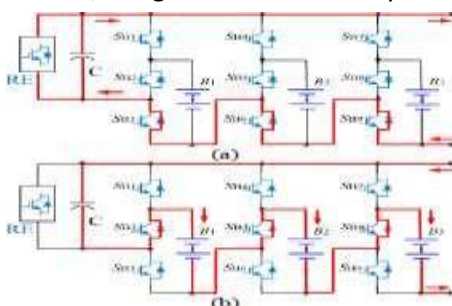

source of power for the motor. The front-end circuit can operate in two different ways, as shown in Figure 4. Figure 4 depicts the functioning mode of the SRM when the generator provides the energy (a). Storage capacitor returns phase winding stored energy to the three battery packs, as indicated in Fig. 4 (below) (b). Demagnetization will proceed much faster since the phase winding can be exposed to a higher negative voltage.

Fig. 4. Working conditions of the front-end circuit

by the generator. (a) Driving mode. (b) Energy regeneration mode.

As referenced over, the entire conduction district of stage A can be isolated into five areas. In Region I, stages An and B can both be in the excitation or freewheeling states. Henceforth, four conduction methods of the AHB converter are begotten. In Region II, stage C must be in demagnetization state, and stage A can be in excitation or freewheeling states. At the point when stage An is in excitation state, stage C is in demagnetization state, and stage C current is greater than stage A current, the vitality of stage C is utilized to control stage An and took care of back to the battery packs. In Region III, there is just stage A leading in the excitation or freewheeling states. In Regions IV and V, the activity modes are like those in Regions I and II, separately.

4) Driving Modes by the Battery Packs

5) If J is killed at this moment, the SRM can operate in its pure battery mode. In the front-end circuit shown in Fig. 4, the

distinctive voltage levels can be obtained by regulating the switches in the BM modules. When the front-end circuit is off, the three battery packs are connected in parallel and each branch contains a diode to limit the current flow, as shown in Fig. 5, which demonstrates this (a). Because the SOC of a battery pack is directly related to its voltage, the one with the highest SOC will also have the highest voltage. A diode in each branch will latently hinder the other battery packs from supplying power to the engine, so the

one with the highest SOC will naturally direct power to the engine. As shown in Fig. 5, the two battery packs B1 and B2 are linked together to regulate the engine when switch SB5 is turned on (b). Fig. 5 shows how the battery pack B3 and the other one with the greater SOC in the rest are connected in order to provide power when switch SB8 is turned on (c). Switches SB5 and SB8 are both turned on at the same time, resulting in Fig. 5's configuration of the three modules controlling the engine, as shown (d).

Fig. 5. Working conditions of the front-end circuit by the battery packs. (a) Mode 1. (b) Mode 2. (c) Mode 3. (d) Mode 4.

During times when the vehicle is under a lot of stress, the battery packs can be linked together to increase the vehicle's

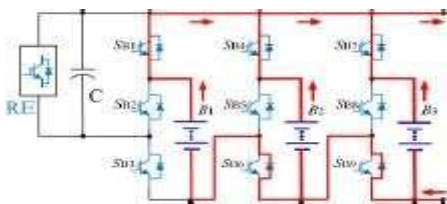

power. Fig. 6 shows that when all of the switches SB1, SB4, and SB7 are turned on, the three battery packs are linked together in order to increase the flow of electricity. The higher force can be generated in order to meet the requirement of an overwhelming burden or a difficult situation.

Fig. 6. Working condition of the front-end circuit under heavy load or uphill condition.

Under the pure-battery driving mode, the conduction modes of AHB converter are same to those under generator powered driving modes. When the energy stored in the phase winding needs to be fed back to front-end circuit, the energy feedback flow is same to that in Fig. 4(b).

6) Driving Modes by the Generator and Battery Packs

7) As shown in Fig. 7, seven operating modes may be obtained by activating the hand-off J and working with the switches in the front-end circuit when the generator and battery packs should drive the engine jointly. In conjunction with the generator, one, two, or all of the SRM's battery packs can be used to power the SRM.

Fig. 7 Working conditions of the front-end circuit by the generator and battery packs. (a) Mode 1. (b) Mode 2. (c) Mode 3. (d) Mode 4.

Fig. 7 shows the arrangement of the generator and the battery pack B1 when the switch SB2 is turned on (a). For example, as shown in Fig. 7, when the battery packs B2 and B3 are working, their activity modes may be seen in (b) and (c). Generator B1 and B2 are connected to the engine when switches SB2 and SB5 are both turned on, as depicted in Fig. 7 (Fig. 7). (d).

B. Regenerative Braking Modes

C. The engine can be used to charge the battery packs when the SRM is in a regenerative slowing down mode. Figure 7) As shown in Fig. 7, seven operating modes may be obtained by activating the hand-off J and working with the switches in the front-end circuit when the generator and battery packs should drive the engine jointly. In conjunction with the generator, one, two, or all of the SRM's battery packs can be used to power the SRM.

Fig. 7 Working conditions of the front-end circuit by the generator and battery packs. (a) Mode 1. (b) Mode 2. (c) Mode 3. (d) Mode 4.

Fig. 7 shows the arrangement of the generator and the battery pack B1 when the switch SB2 is turned on (a). For example, as shown in Fig. 7, when the battery packs B2 and B3 are working, their activity modes may be seen in (b) and (c). Generator B1 and B2 are connected to the engine when switches SB2 and SB5 are both turned on, as depicted in Fig. 7 (Fig. 7). (d).

B. Regenerative Braking Modes

C.The engine can be used to charge the battery packs when the SRM is in a regenerative slowing down mode. Figure

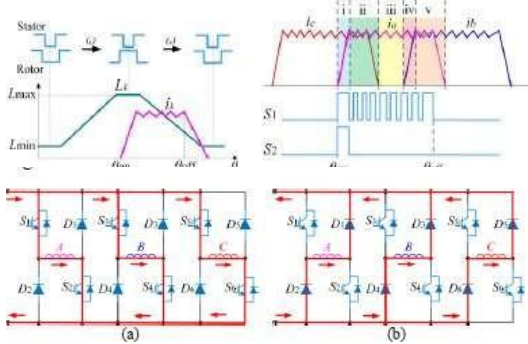

8(a) shows the regenerative slowing down mode stage current and inductance waveforms. The decreasing stage inductance area is where the negative force is generated. In Figure 8(b), we see the stages and drive signals that go along with them. Stage A, for example. Stage A's complete conduction span can be divided into five distinct sections. In Region I, the underlying current can be constructed by selecting one of the driving modes shown in Figures 4(a), 5, 6, and 7. The freewheeling and demagnetization states are used in the other four locations to give the negative force for slowing down activity and to restore the battery packs' vitality. The front-end circuit's power recovery mechanism is identical to that depicted in Fig. 4. (b).

Fig.8.Regenerativebrakingcondition.(a)Relationshipbetweenphasecurrentandphaseinductance.(b)Phasecurrentsand drivesignals.

The AHB converter's conduction methods will be analyzed independently in each of the converter's five districts when in regenerative slowing down mode. Three AHB converter conduction mechanisms are possible in Region I. Whenever stage An is in an excitation state and stage C is in a demagnetization state, the vitality of stage C is used to control stage An and the force generated in an excitation state. Stage C is used to control stage An and the force generated in a demagnetization state. Stage C is used to control stage An and the force generated in an excitation state and stage C is used to control stage An and the force generated in a demagnetization state.

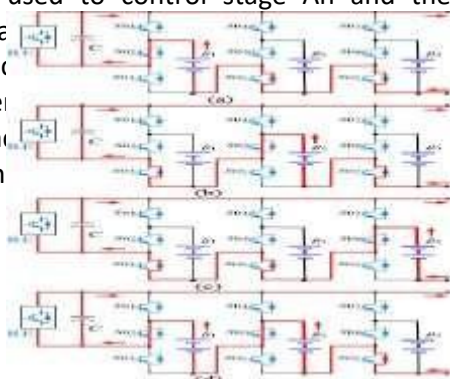

stage C in a demagnetization state, stage An ebb and flow is greater. In the excitation condition of stage An and the freewheeling state of stage C, only the force can gracefully govern stage A. Demagnetization and freewheeling states are possible for stages An and C in Region ii. The AHB converter now has four modes of operation. The energy stored in the stage winding will be returned to control flexibly if any of the stages are put under demagnetization express. In the freewheeling or demagnetization states, only stage A is leading in Region iii. The activity modes in Regions iv and v are identical to those in Regions I and ii.

E. ChargingModes

F.The generator or air conditioner matrix can recharge the battery packs when the engine is stopped. When the transfer J is activated, the generator provides the power. Air conditioner network provides force when the hand-off J is terminated and the air conditioner plug is linked to Air Conditioner Matrix. The three stage windings are used as inductors and the proposed converter geography is used as a dc/dc support charging circuit to achieve the charging capacity under stop situation. There are two stages to the charging process: The three-stage windings are initially charged with the dc voltage from the rectifier by turning on all the switches in the AHB converter and turning off all the switches in the front-end circuit. Figure 9(a) depicts the AHB converter's conduction technique, while Figure 4(a) depicts the front-end circuit in operation. In addition, by disabling the AHB converter's switches, the three-stage windings' stored vitality will be used to charge the battery packs. As may be seen in Fig. 9, the AHB converter's conduction method is illustrated (b).

Fig. 9. Conduction states of AHB converter understandstillchargingcondition.(a)Conductionstate1.

(b)Conductionstate2.

III.

CONTROLSTRATEGIESOFTHEPROPOSED AHB CONVERTER

A.ControlStrategy underDrivingModes

By and large, two great control procedures are received in the SRM drive framework, including current cleaving control (CCC) [14] and voltage-

Using PWM (VPC) control [15]. Figure 11 depicts the SRM control architecture as a square. For

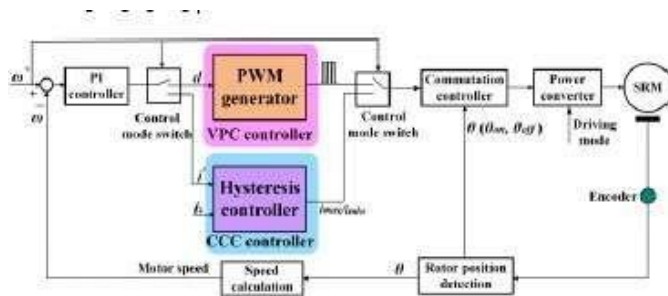
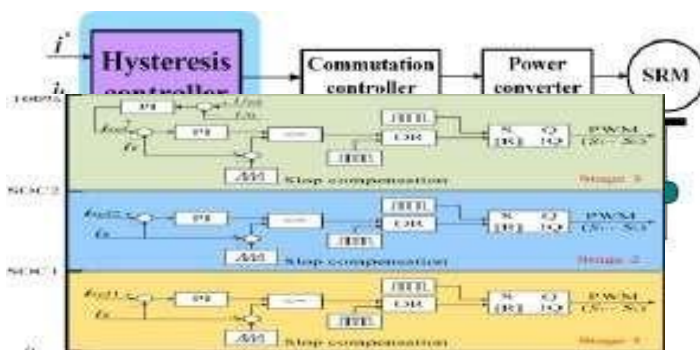

Fig.10. Control strategy under driving modes.

replacement control and speed estimation, a rotor position encode is used. For controlling the speed of the shut circle, a relative basic (PI) controller is used. Using the control mode switch, you can select the control systems based on the speed of the vehicle you are driving. The engine is powered by the vehicle's driving mode. The engine speed is used to select the CCC and VPC control systems in driving mode. When the engine is running at a lesser speed, the CCC technique is used, while the VPC strategy is used at a greater speed. The various driving modes can be selected to meet different activity requirements, for example, starting, speeding up, and slowing down. The voltage weight on the switches and the exchange misfortune can be reduced by using the appropriate driving modes [14].

At the point when the engine is under the regenerative slowing down mode, the SRM control framework is shown in Fig.11. There regenerative slowing down mode is utilized for slowing down with vitality input, which can be viewed as autonomous from the driving mode. To keep away from the overcurrent harm and actualize the e-beat charging process, the CCC is utilized to control the stage current. As indicated by slowing down activity, the distinctive slowing down current can be set for the inertial slowing down, slow slowing down, and brisk slowing down. In the mean time, the vitality put away in the stage windings can be utilized to charge the battery packs.

Fig. 11. Control strategy under regenerative braking modes. C. Control Strategy under Charging Modes



The suggested converter can be used as a charger for the modules when the engine is stopped and the SOC of the battery packs is low. As shown in Fig. 12, the charging process can be divided into three stages based on the SOC. Battery pack SOC is midway between 0 and SOC1 in Stage 1, which indicates

that the battery pack is in an extreme state of depletion. The pre-charging stage is essential, and a lower consistent current (for example, i_{ref1}) charging mode is used to protect the battery packs from essential damage. A conventional constant-current charging mode (for example, i_{ref2}) is used when the battery pack's SOC is between

SOC1 and SOC2. When the battery pack's SOC is between SOC2 and 100 percent in Stage 3, a steady voltage charging mode is used to ensure that the battery pack is fully charged.

Fig.12. Control strategy under charging modes. For the proposed converter geography, as indicated by the activity conditions, the ideal voltage level will be arranged to control the engine. Thus, the SOC contrast among the three battery packs might be caused. So as to shield the battery packs from over discharge issue, the SOC balance control is significant under driving modes. What's more, to shield the battery packs from the heat issue, the SOC balance control is additionally essential under regenerative slowing down and stop charging modes.

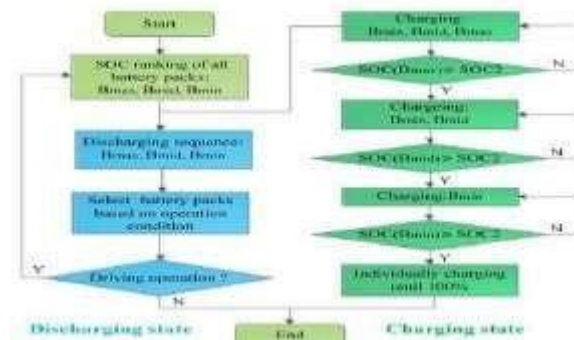

Fig.13. SOC balance control strategy.

Fig. 13 presents the SOC balance control technique under releasing and charging states. The SOC of all battery packs is positioned at normal spans. Under releasing state, the released arrangement is gotten by the SOC, from the most noteworthy to least. As indicated by the activity prerequisite, the battery pack with higher SOC will be right off the bat used to control the engine. Thus, the SOC of the battery packs can accomplish the dynamic parity under releasing states. Under charging state, to evade the heat and lessen the charging time, the accompanying procedure is embraced. Right off the bat, the three battery packs are at the same time charged until the most elevated SOC reach SOC2. Furthermore, the rest two packs keep being charged until the medium SOC reach SOC2. Thirdly, the last module is charged until the SOC reach SOC2. At long last, to ensure the battery packs are completely energized, the

modules are independently charged under steady voltage charging mode.

IV. ANFIS CONTROLLER

An Adaptable System for Neuro-Fuzzy Inference An AFIS, or adaptable structure-based fleecy thinking framework, is a fraud brain structure based on the Takagi-Sugeno comfy enlisting organize. In the mid-1990s, the system was developed. It is able to combine the advantages of neural frameworks and padded introduction measures in a single structure. If-Then selections with the capacity to incorrectly learn nonlinear bounds are used in its enlisting form. As a result, ANFIS is regarded as a complete estimator. In order to use the ANFIS in a more efficient and accurate manner, one can employ the best parameters calculated via innate computations. This is referred to as an ANFIS system.

As far as practicality is concerned, ANFIS are indistinguishable from fluff structures.

Two padding models are addressed by ANFIS: Sugeno and Tsukamoto.

A mutt is learning to figure out ANFIS.

Neuro-padded surmises in the realm of automated reasoning combine brain structures with woolen support. Hybridization of the padded structures with the learning and connectionist structures of neural frameworks results in a neuro-cushy structure that combines these two tactics in a way that is human-like. Fuzzy neural networks (FNNs) and neuro-fuzzy systems (NFSs) are common names for neuro-padded hybridizations in the literature. Wiring the woolen system's human-like reasoning style using cushy sets and an approach to IF-THEN padded principles, the term neuro-fluffy structure (the more conventional word is used from this time forward) is wired. Neuro-fluffy structures are conceived of as having the ability to ask for interpretable IF-THEN rules, regardless of how you look at it. Cushy appearances are tethered to two conflicting requirements: interpretability versus precision. Whichever property has the best interior and outside will be the winner. There are two distinct areas of neuro-warm padded demonstrating research: semantic delicate exhibiting, which relies on

interpretability, and right fluffly exhibiting, which relies on precision, in broad terms. Interpretability of the Mamdani-type neuro-cushy frameworks can be lost by the use of multi-layer feed-forward connectionist structures.

Fig14.Input_1

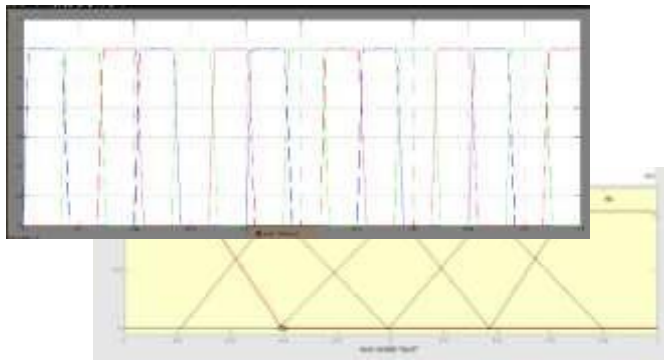

Fig15Input_2

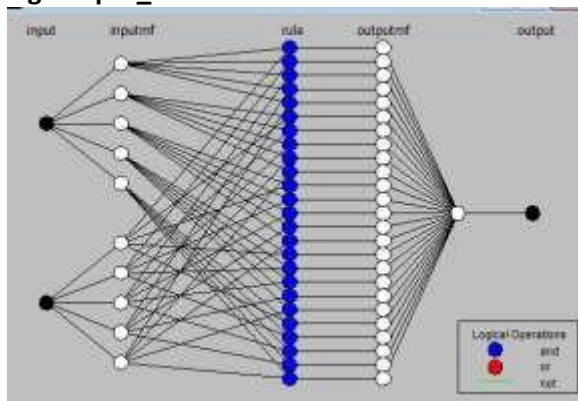

Fig16.Anfisstructure



V. Simulationresults

voltage

Fig..Simulationresultsat1500r/mininPWMsystem.(a) Driving modebythreebattery packs. Simulationresultsunderregenerativebraking condition.(a)Inertialbrakingcondition.



**SimulationresultsbyusingANFIScontroller
Simulationresultsunderregenerativebraking**

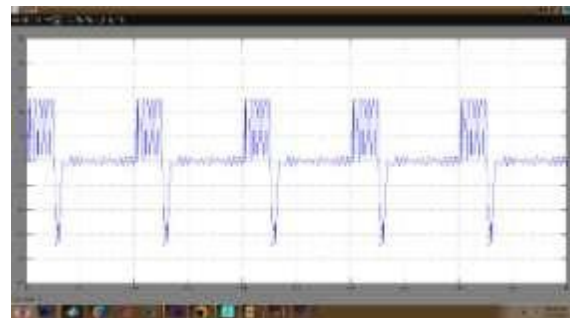

condition.(a)Inertialbrakingcondition.



Conclusion

A cascaded multi-port converter employing ANFIScontroller is proposed for SRM-based HEV applications in this study. Batteries, generator/air conditioning lattice, and engine are all integrated into a single AHB converter to achieve the flexible vitality transformation needed. In the proposed coordinated converter geography, drivers can select from a variety of driving modes, regenerative slowing down modes, and charging modes.

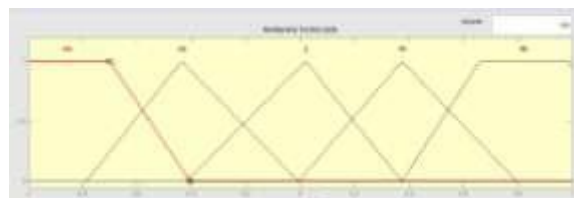

Acknowledging staggered transport voltages and current limits, which can speed up the excitation and demagnetization processes during recompense, expand the speed range

and reduce voltage weight on the switches and improve force capacity and framework efficiency by incorporating fell BM modules

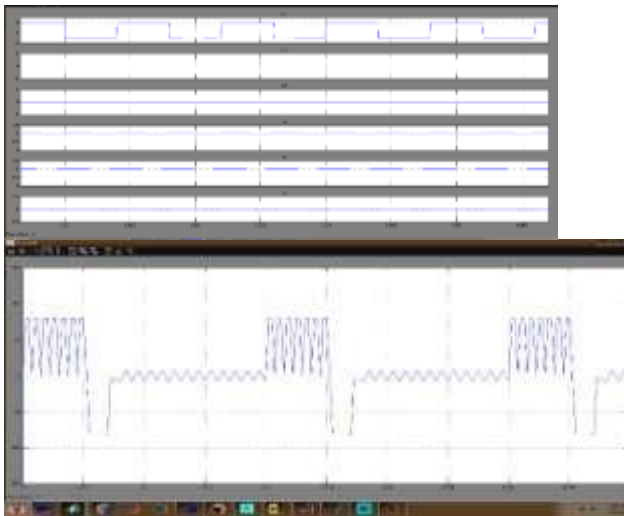

into the proposed converter. In a running system, the battery packs can be charged by the demagnetization current; in a stopped system, the generator/air conditioning network can be used to charge them. It is also possible to avoid cheating and overdischarging difficulties due to the suggested SOC balance control procedure under the charging and releasing stages. The fall BM modules, on the other hand, provide for a flexible modification to internal failure capacity. It is thus possible to extend the suggested fall multi-port converter to a wide range of applications, including as electric airplanes, footing drives, and electrical boats.labc

REFERENCES

- [1] IEEE Transactions on Industrial Applications (IET) Volume 52, Issue 4, pp. 3294-3305, 2016. [1] S. Kimura et al., "Downsizing effects of integrated magnetic components in high-power density DC/DC converters for EV and HEV applications".
- [2] IEEE Trans. Power Electron. 30(8): 4264-4270, August 2015. [2] D. Moon, J. Park, and S. Choi, "New interleaved current-fed resonant converter with greatly reduced high current side output filter for EV and HEV applications,"
- [3] IEEE Transactions on Industrial Applications, vol. 52, no. 3, May/June 2016, pp. 2046-2052 (A linear program for system-level control of regional PHEV charging stations), A. Kulvanitchaiyunt, V. C P. Chen,

J." Rosenberger, P." Sarikprueck," and W. J Lee.

[4] A PHEV charging infrastructure can be modelled using small-signal modeling and networked control, according to the IEEE Transactions on Industrial Applications.

[5] An analysis of torque capability and quality in vernier permanent-magnet

machines, published in IEEE Transactions on Industrial Applications in January/February 2016, by D. Li, R. Qu, J. Li, L. Xiao, L. Wu, and W. Xu. [6] IPMSMs for electric vehicle applications: a fuzzy model predictive direct torque control approach, in IEEE/ASME Transactions on Mechanical Engineering, vol 22, no 4, 2017, pp 1542-1553, by J. J. Justo, F. Mwasilu, E. K. Kim, J. Kim, H. H. Choi and J. W. Jung [6].

[7] When it comes to electric vehicle (EV) applications, it's important to understand the differences between PM-assisted SynRM and IPMSM on a constant power speed range (CPS).

[8] An overview of the automotive electric propulsion systems with decreased or non-permanent magnet systems is presented in the IEEE Transactions on Industrial Electronics, Volume 61, Issue 10, pp. 5696–5711.

[9] Comparative analysis of interior permanent magnet, induction, and switching reluctance motor drives for EV and HEV applications," IEEE Transactions on Transportation Electrification, vol. 1, no. 3, pp.245-254 in October 2015, IEEE.

[10] "[10] A. Chiba, N. Hoshi, M. Takemoto, and S. Ogasawara, "Development of a rare-earth-free Sr motor for hybrid vehicles," IEEE Trans. Energy Convers., vol. 30, no. 1, pp. 175-182, March 2015."

[11] To compete with a 60-kW IPMSM in the third generation of hybrid electric vehicles, K. Kiyota and A. Chiba designed a switching reluctance motor (SRM).

[12] F. L. M. d. Santos, J. Anthonis, F. Naclerio, and J. J. J. Anthonis [12]

[13] IEEE Transactions on Industrial Electronics (TIE) Vol. 61, No. 1, January 2014,

pp. 469-476. [13] Switched-reluctance electric vehicle motor simulation utilizing multiphysics NVH modeling. For four-phase SRM drive

with improved converter topology and no voltage penalty using a new phase current reconstruction scheme for four-phase SRM drives, see "A new phase current reconstruction scheme for four-phase SRM drives using improved converter topology and no voltage penalty," published in IEEE Transactions on Industrial Electronics in January 2018.

[14] IEEE Trans. Power Electron, vol. 22, no. 5, pp. 2034-2041, 2007, L. Dong-Hee and A. Jin-

Woo, "A Novel four-level converter and instantaneous switching angle detector for high speed SRM drive."

[15] Review on the configurations of hybrid electric vehicles, by Ewc Lo in the proceedings of the 3rd international conference of the PESA, held in Hong Kong in May of 2009 (pp. 1-4).